

## Features

- Centimeter-level Accurate
- Dual Frequency RTK GPS L1/L2
- Hardware-ready for:
  - GLONASS G1/G2
  - BeiDou B1/B2
  - Galileo E1/E5b
  - QZSS L1/L2
  - SBAS
- 20 Hz Solution Rate
- On-board MEMS IMU and Magnetometer
- Flexible Interfaces
  - UART
  - Ethernet
  - CAN
  - USB
- Communication Protocols
  - Swift Binary Protocol
  - NMEA 0183
- External Clock Input
- 32 User-definable GPIO Pins for Customization
- Wide power supply range: 5.0 - 15.0 V DC
- Linux Open Platform
- Low Cost

## Applications

- Autonomous Vehicle Guidance
- Precision Agriculture
- Robotics
- Unmanned Aerial Vehicles
- GPS / GNSS Research
- Structural / Land Monitoring
- Offshore / Marine Applications

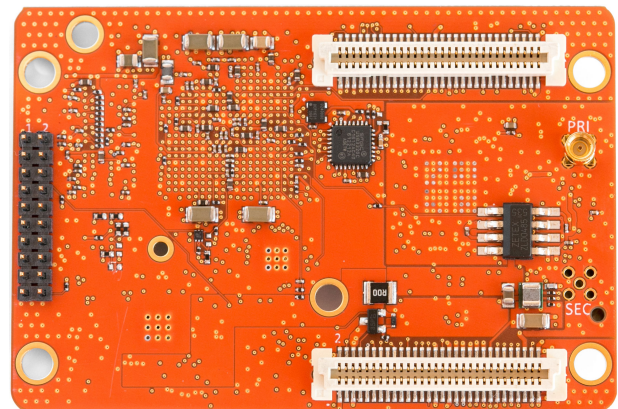
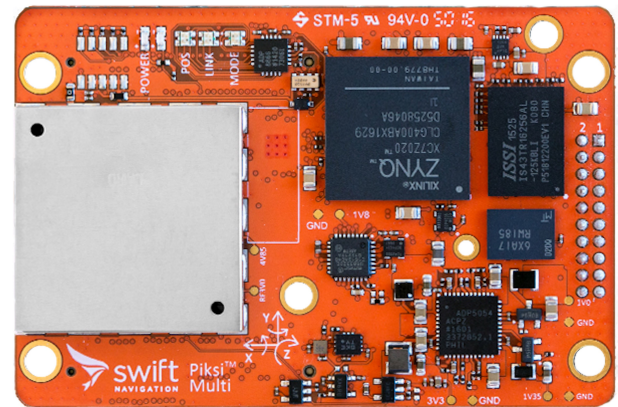

Figure 1: Pixsi Multi - Top and Bottom View

## Overview

Piksi™ Multi is a low-cost, high-performance GNSS receiver with Real Time Kinematics (RTK) technology for centimeter-level positioning accuracy. Its small form factor, fast position solution update rate and robust feature set make Pixsi Multi ideal for integration into autonomous vehicles and robotics. Multi-band and multi-constellation support enable Pixsi Multi to offer fast RTK convergence times. Integrated MEMS inertial measurement unit (IMU) and magnetometer enable sensor fusion techniques.

## System Architecture

The Piksi Multi receiver architecture consists of two primary components: the RF front-end and the Xilinx Zynq 7020 system on a chip. The RF front-end downconverts and digitizes the radio frequency signal from the antenna. The digitized signal is passed into the programmable logic of the Xilinx Zynq 7020.

The programmable logic is defined by the SwiftNAP to perform basic filtering and correlation operations on the signal stream. The SwiftNAP is controlled by the processing system of the Xilinx Zynq 7020 which programs the correlation operations, collects the results and processes them all the way to position/velocity/time (PVT) solutions.

### Signal Tracking

Historically, the GNSS industry has used the number of tracking channels available on a receiver as a measure of its signal tracking capability. This is likely an artifact of receivers traditionally being designed to utilize ASICs with individual tracking channels for different constellations and frequencies. Unfortunately, it is often the case that the number of tracking channels is also conflated with the number of correlators.

Piksi Multi employs a unique design, which does not utilize an ASIC. Instead, the tracking and correlation duties are serviced by the programmable logic of the Zynq 7020. This allows Piksi Multi to be extremely flexible with regards to how tracking and correlation resources are allocated; it also makes comparisons of tracking channel count largely irrelevant.

Piksi Multi is capable of simultaneous tracking of L1 and L2 signals from up to 22 satellites.

### Xilinx Zynq 7020

The on-board system on chip is a Xilinx Zynq 7020, equipped with dual-core ARM Cortex-A9 processors running at 666 MHz. This powerful SoC performs all GNSS functions above the correlator level including tracking loop filters, acquisition management and navigation processing. The Zynq 7020 runs Linux on-board to enable seamless integration of customer applications.

### SwiftNAP

The SwiftNAP utilizes the programmable logic of the Zynq 7020 SoC and comes pre-programmed with Swift Navigation's SwiftNAP firmware. The SwiftNAP contains correlators specialized for satellite signal tracking and acquisition.

### IMU and Magnetometer

The Piksi Multi module has on-board, high quality, MEMS grade sensors to allow for sensor fusion.

#### IMU - Bosch BMI160

- Acceleration Range (Selectable)  
 $\pm 2 g, \pm 4 g, \pm 8 g, \pm 16 g$
- Gyroscope Range (Selectable)  
 $\pm 125, \pm 250, \pm 500, \pm 1000, \pm 2000$  ( $^{\circ}/s$ )
- Resolution: 16 bit

#### Magnetometer - Bosch BMM150

- Magnetic Field Range (X,Y):  $\pm 1300 \mu T$
- Magnetic Field Range (Z):  $\pm 2500 \mu T$
- Magnetic Field Resolution:  $\pm 0.3 \mu T$

These MEMS sensors are intended for customers to use in their own application. At this moment, Swift Navigation has no immediate plans to provide a tightly coupled GPS-INS positioning solution, however, this may change in the near future. The Piksi Multi will have the ability to output raw data from these sensors through via [Swift Binary Protocol](#) at data rates up to 200 Hz.

## Block Diagram

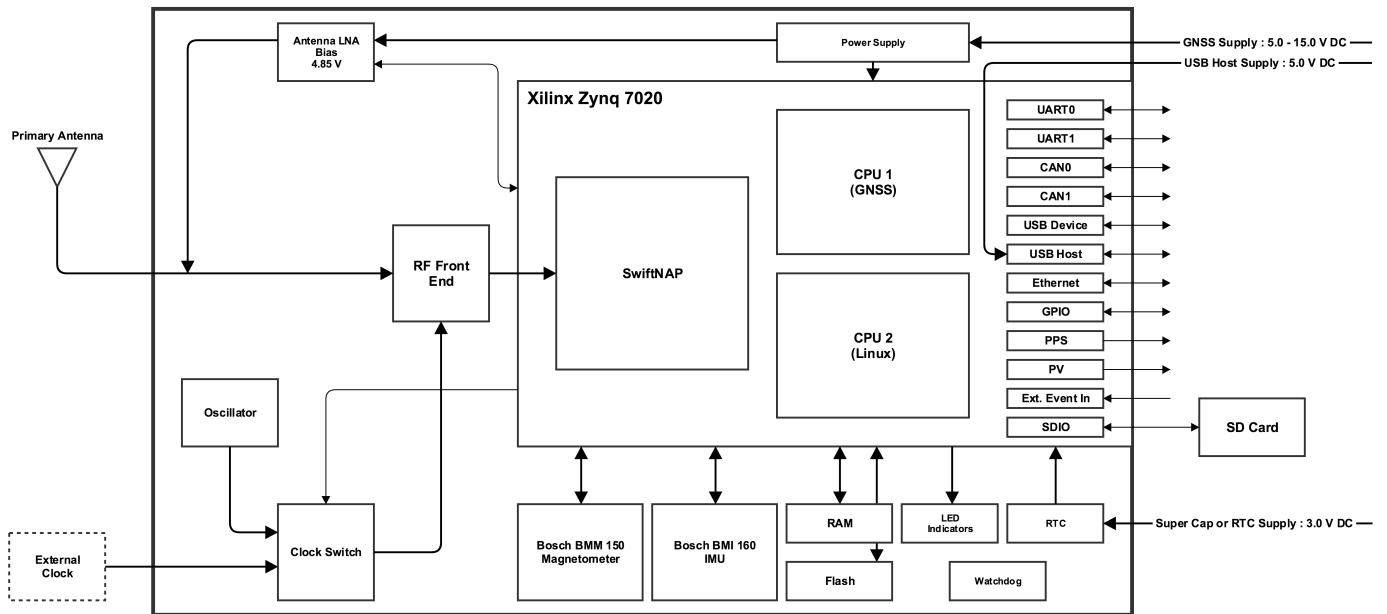

Figure 2: Piksi Multi Block Diagram

# Connections

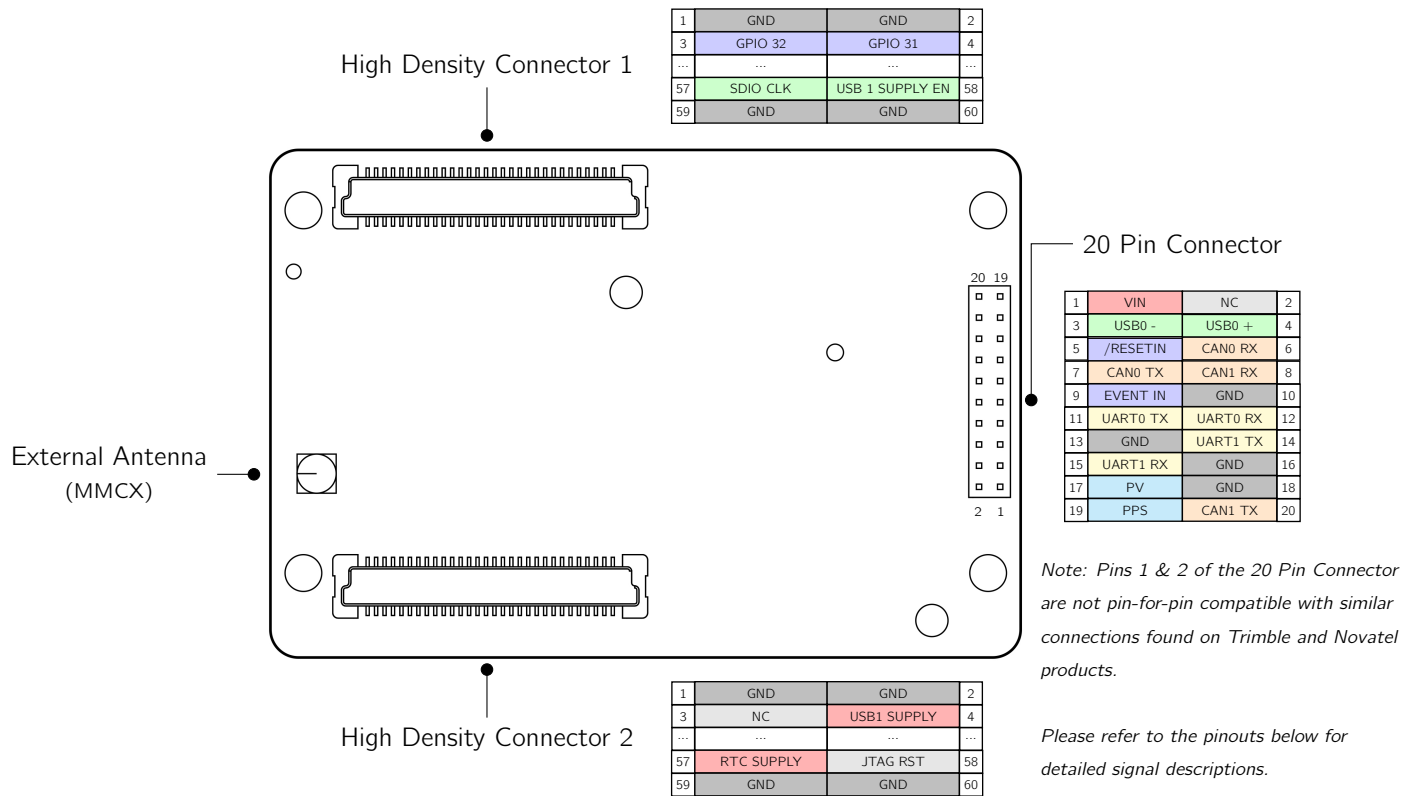

Figure 3: Connections - Bottom View

## External Antenna

The MMCX connector serves as the input for an external active antenna. It is required to use an antenna with more than 25dB of gain.

## Power

Power may be supplied to the board via the 20 pin or the High Density connectors. Do not supply power to both simultaneously. See the pinouts below for connection details. Operating ranges can be found in the Electrical Specifications section.

## 20 Pin Connector

Part Number: TMM-110-03-F-D-ND - Mating Connector Part Number: TLE-110-01-G-DV-A-TR

Pin #	Connection	I/O	Notes	Pin #	Connection	I/O	Notes
1	VIN	PWR	Input voltage (5.0-15.0 VDC)	2	NC	DNC	Not Connected
3	USB0_D_N	I/O	USB0 Data -	4	USB0_D_P	I/O	USB0 Data +
5	/RESETIN	I	Active low reset	6	CAN0_RX	I	CAN bus 0 - RX
7	CAN0_TX	O	CAN bus 0 - TX	8	CAN1_RX	I	CAN bus 1 - RX
9	EVENT_IN	I	External Event Marker	10	DIG_GND	PWR	Ground
11	UART0_TX	O	UART 0 - TX	12	UART0_RX	I	UART 0 - RX
13	DIG_GND	PWR	Ground	14	UART1_TX	O	UART 1 - TX
15	UART1_RX	I	UART1 - RX	16	DIG_GND	PWR	Ground
17	PV	O	Position Valid	18	DIG_GND	PWR	Ground
19	PPS	O	Pulse Per Second Out	20	CAN1_TX	I	CAN bus 1 - TX

## High Density Connector 1

Part Number: 61082-061400LF - Mating Connector Part Number: 61083-062400LF

Pin #	Connection	I/O	Notes	Pin #	Connection	I/O	Notes
1	DIG_GND	PWR	Ground	2	DIG_GND	PWR	Ground
3	GPIO_32	I/O	GPIO 32	4	GPIO_31	I/O	GPIO 31
5	VIN_CONN	PWR	Input voltage (5.0 - 15.0 VDC)	6	VIN_CONN	PWR	Input voltage (5.0 - 15.0 VDC)
7	USB_1.D.P	I/O	USB1 Data +	8	/RESETIN	I	Active low reset
9	USB_1.D.N	I/O	USB1 Data -	10	EVENT_IN	I	External Event Marker
11	GPIO_33	I/O	GPIO 33	12	GPIO_30	I/O	GPIO 30
13	ENET0_TX_CLK	O	Ethernet TX Clock	14	ENET0_RX_CLK	I	Ethernet RX Clock
15	ENET0_TXD0	O	Ethernet TX [0]	16	ENET0_RXD0	I	Ethernet RX [0]
17	ENET0_TXD1	O	Ethernet TX [1]	18	ENET0_RXD1	I	Ethernet RX [1]
19	ENET0_TXD2	O	Ethernet TX [2]	20	ENET0_RXD2	I	Ethernet RX [2]
21	ENET0_TXD3	O	Ethernet TX [3]	22	ENET0_RXD3	I	Ethernet RX [3]
23	ENET0_TX_CTL	O	Ethernet TX Control	24	ENET0_RX_CTL	O	Ethernet RX Control
25	PV	O	Position Valid	26	ENET0_MDC	O	Ethernet Management Data Control
27	PPS	O	Pulse Per Second	28	ENET0_MDIO	I/O	Ethernet Management Data I/O
29	DIG_GND	PWR	Ground	30	DIG_GND	PWR	Ground
31	NC	DNC	Not Connected	32	ENET0_RST	O	Ethernet Reset
33	VIN_CONN	PWR	Input voltage (5.0 - 15.0 VDC)	34	VIN_CONN	PWR	Input voltage (5.0 - 15.0 VDC)
35	EXT_CLK	I	External Clock Input	36	DIG_1V0	DNC	Do Not Connect
37	UART0_TX	O	UART 0 TX (LVTTTL)	38	DIG_1V35	DNC	Do Not Connect
39	UART0_RX	I	UART 0 RX (LVTTTL)	40	DIG_1V8	DNC	Do Not Connect
41	UART0_RTS	O	UART 0 RTS (LVTTTL)	42	DIG_3V3	DNC	Do Not Connect
43	UART0_CTS	I	UART 0 CTS (LVTTTL)	44	RF_4V85	DNC	Do Not Connect
45	CAN0_RX	I	CAN 0 RX (LVTTTL)	46	RF_3V3	DNC	Do Not Connect
47	CAN0_TX	O	CAN 0 TX (LVTTTL)	48	SDIO_D0	I/O	SD Card D0
49	SDIO_CMD	O	SD Card Command	50	SDIO_D1	I/O	SD Card D1
51	SDIO_CD	I	SD Card Card Detect	52	SDIO_D2	I/O	SD Card D2
53	SDIO_WP	O	SD Card Write Protect	54	SDIO_D3	I/O	SD Card D3
55	VIN_CONN	PWR	Input voltage (5.0 - 15.0 VDC)	56	VIN_CONN	PWR	Input voltage (6 - 15 VDC)
57	SDIO_CLK	O	SD Card Clock	58	USB1_SUPPLY_EN	O	USB Host Supply Enable
59	DIG_GND	PWR	Ground	60	DIG_GND	PWR	Ground

## High Density Connector 2

Part Number: 61082-061400LF - Mating Connector Part Number: 61083-062400LF

Pin #	Connection	I/O	Notes	Pin #	Connection	I/O	Notes
1	DIG_GND	PWR	Ground	2	DIG_GND	PWR	Ground
3	GPIO_34	I/O	GPIO 34	4	USB1_SUPPLY	I	USB Host Supply Detect
5	VIN_CONN	PWR	Input voltage (5.0 - 15.0 VDC)	6	VIN_CONN	PWR	Input voltage (5.0 - 15.0 VDC)
7	GPIO_0	I/O	GPIO 0	8	UART1_TX	O	UART 1 TX
9	GPIO_1	I/O	GPIO 1	10	UART1_RX	I	UART 1 RX
11	GPIO_2	I/O	GPIO 2	12	UART1_RTS	O	UART 1 RTS
13	GPIO_3	I/O	GPIO 3	14	UART1_CTS	I	UART 1 CTS
15	GPIO_4	I/O	GPIO 4	16	GPIO_20	I/O	GPIO 20
17	GPIO_5	I/O	GPIO 5	18	GPIO_21	I/O	GPIO 21
19	GPIO_6	I/O	GPIO 6	20	GPIO_22	I/O	GPIO 22
21	GPIO_7	I/O	GPIO 7	22	GPIO_23	I/O	GPIO 23
23	GPIO_8	I/O	GPIO 8	24	GPIO_24	I/O	GPIO 24
25	GPIO_9	I/O	GPIO 9	26	CAN1_TX	O	CAN 1 TX
27	FGA_DONE	O	Do Not Connect	28	CAN1_RX	I	CAN 1 RX
29	DIG_GND	PWR	Ground	30	DIG_GND	PWR	Ground
31	PWR_GOOD	O	Digital Supplies OK	32	GPIO_25	I/O	GPIO 25
33	VIN_CONN	PWR	Input voltage (5.0 - 15.0 VDC)	34	VIN_CONN	PWR	Input voltage (5.0 - 15.0 VDC)
35	GPIO_10	I/O	GPIO 10	36	GPIO_26	I/O	GPIO 26
37	GPIO_11	I/O	GPIO 11	38	GPIO_27	I/O	GPIO 27
39	GPIO_12	I/O	GPIO 12	40	GPIO_28	I/O	GPIO 28
41	GPIO_13	I/O	GPIO 13	42	GPIO_29	I/O	GPIO 29
43	GPIO_14	I/O	GPIO 14	44	I2C1_SDA	I/O	I2C1 Serial I/O
45	GPIO_15	I/O	GPIO 15	46	I2C1_SCL	O	I2C1 Serial Clock
47	GPIO_16	I/O	GPIO 16	48	JTAG_TDO	DNC	Do Not Connect
49	GPIO_17	I/O	GPIO 17	50	JTAG_TCK	DNC	Do Not Connect
51	GPIO_18	I/O	GPIO 18	52	JTAG_TDI	DNC	Do Not Connect
53	GPIO_19	I/O	GPIO 19	54	JTAG_TMS	DNC	Do Not Connect
55	VIN_CONN	PWR	Input voltage (5.0 - 15.0 VDC)	56	VIN_CONN	PWR	Input voltage (5.0 - 15.0 VDC)
57	RTC_SUPPLY	PWR	Real Time Clock Supply (3.0 VDC)	58	JTAG_/RST	DNC	Do Not Connect
59	DIG_GND	PWR	Ground	60	DIG_GND	PWR	Ground

## LED Indicators

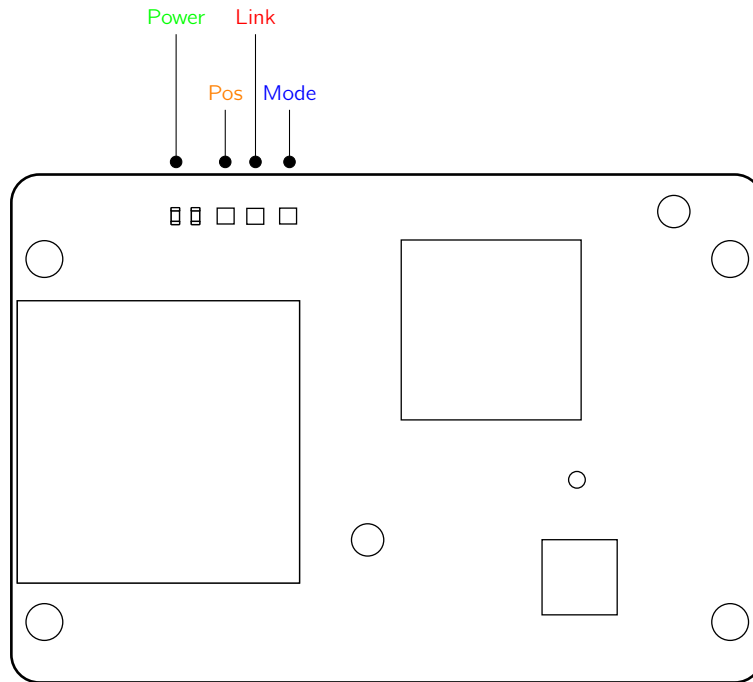

Figure 4: LED Indicators - Top View

LED Name	Color	State	Description
<b>POWER</b>	LED Off	Off	No Power
	Green	Continuously On	Module receiving power
<b>POS</b>	LED Off	Off	Antenna missing or not detected
	Orange	Slow Blink	Antenna connected but no satellites tracked
	Orange	Fast Blink	Tracking satellites - e.g. > 1 satellites tracked
	Orange	Continuously On	GNSS Solution Available
<b>LINK</b>	LED Off	Off	No incoming corrections
	Red	Variable Blink	Incoming corrections
<b>MODE</b>	LED Off	Off	No RTK
	Blue	Blinking	Float RTK
	Blue	Continuously On	Fixed RTK

## Digital Interfaces

### USB

Two USB connections are available, one device (USB0) and one host (USB1). USB0 is available via the 20 pin connector. USB1 is available via High Density Connector 1. See pinouts above for connection details.

By default, USB0 is configured as a Common Device Class serial port. In this configuration, connection baud rate is not acknowledged and the device will operate at the line speed of the USB connection.

### UART

Two UART provide high-speed 3.3V level asynchronous serial interfaces which can be configured to transmit NMEA-0183 messages or [Swift Binary Protocol](#) navigation solution data, system status and debugging information and receive commands or differential corrections from the host or another Piksi board. The Uarts are not 5 volt tolerant.

Piksi Multi supports baud rates of up to 921600 bps. Both UARTs are configured with a default baud rate of 115200 bps. UART0 and UART1 are available via High Density Connector 1 and High Density Connector 2, respectively. Both UARTs are also available via the 20 Pin connector. Connections made via the High Density connectors support hardware flow control. See pinouts above for connection details.

The Piksi Multi Evaluation Board provides DE9 connections and line-level shifters to convert from LVTTTL to RS232 levels.

### Ethernet

Piksi Multi provides 100 Mbps ethernet connectivity via High Density Connector 2. See pinouts above for connection for details. By default, it provides a TCP stream of SBP data and is configured as follows:

- Static IP: 192.168.0.222
- Network Mask: 255.255.255.0
- Gateway Address: 192.168.0.1
- DNS Nameservers: 8.8.8.8, 8.8.4.4
- SBP TCP Port: 55555

The Piksi Multi Evaluation Board provides an RJ45 port for ethernet access.

### CAN Bus

Two CAN bus connections are available on Piksi Multi. Both CAN0 and CAN1 are comprised of 3.3V level transmit and receive lines and an external transceiver is required. CAN0 and CAN1 operate at 1 Mbps and are accessible via the 20 pin connector. CAN0 and CAN1 are also accessible via High Density Connector 1 and High Density Connector 2, respectively.

The Piksi Multi Evaluation Board provides a CAN transceiver as well as DE9 connections for CAN bus access.

### PPS

Piksi Multi is equipped with a Pulse Per Second output for external system synchronization. The signal is 3.3V, and the pulse width is user definable. The timing accuracy is  $\pm 60$  ns.

### External Event Input Marker

Piksi Multi is equipped with an External Event Input Marker. This input allows events (e.g. a camera shutter opening) to be accurately timestamped with respect to GPS and UTC time. The input is accessible via Pin 10 on High Density Connector 1. The voltage level is LVCOMS / LVTTTL - do not exceed 3.3 V. Piksi Multi can be set to trigger on a rising edge, a falling edge, or both.

The input can be driven with a totem-pole output, an open-collector output, or simply connect via a switch, relay, optocoupler etc. to ground. No provisions are currently provided internally for debouncing. The timing accuracy is  $\pm 60$  ns. There is a to-be-determined minimum time between events, i.e. after one event has been registered, a second is not guaranteed to be detected unless it is some to-be-determined duration later than the first.

### JTAG

For advanced debugging, JTAG pins are accessible via High Density Connector 2. This allows access to both the Processing System and Programmable Logic of the Xilinx Zynq 7020 SoC. No JTAG adapter is required to develop for the Piksi Multi as the board is supplied with a built-in bootloader.

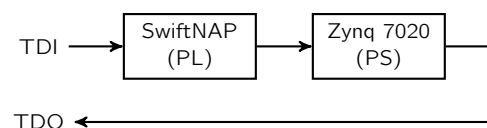

## Electrical Specifications

Max. rated supply voltage .....	15.0 V DC <sup>(1)</sup>	Antenna input impedance .....	50 $\Omega$
Supply voltage range .....	4.85 <sup>(2)</sup> – 15.0 V DC	Antenna bias voltage .....	4.85 V DC <sup>(4)</sup>
Power consumption .....	2.9 W <sup>(3)</sup>	Digital signal levels .....	3.3 V DC <sup>(5)</sup>
Max. antenna bias current draw .....	100 mA		

<sup>(1)</sup>For system where voltage spikes may occur, it is recommended that a protection circuit be integrated between Piksi Multi and the power source.

<sup>(2)</sup>Input voltages lower than 5.0 V DC may decrease antenna bias voltage.

<sup>(3)</sup>Typical, dependant on firmware configuration and supply voltage.

<sup>(4)</sup>Switchable on/off in software

<sup>(5)</sup>Not 5V tolerant

## Thermal Specification

### Overview

Piksi Multi is capable of running up to 80°C without a heatsink. Above, the heatsink included in the kit or another heat sinking strategy is recommended to allow operating temperatures of up to 85°C. The included heatsink has a power dissipation of approximately 10°C/W natural convection. Piksi Multi will automatically shut down in the event of an over-temperature condition and temperature warnings will be available in the SBP messages.

### Heatsink Installation

The included heatsink is designed to fit onto two mounting holes on Piksi Multi. To install the heatsink, remove the tape from over the thermal adhesive on the bottom side of the heat sink. With the board oriented with connectors face-down and the Swift Logo right side up, the heat sink is installed in the top-right corner of the board. A small notch should line up with the mounting hole in the top right corner. The thermal adhesive on the bottom of the heatsink should line up over the part labeled "ZYNQ". When oriented, press the heatsink pins firmly into their associated mounting holes.



## Mechanical Drawing

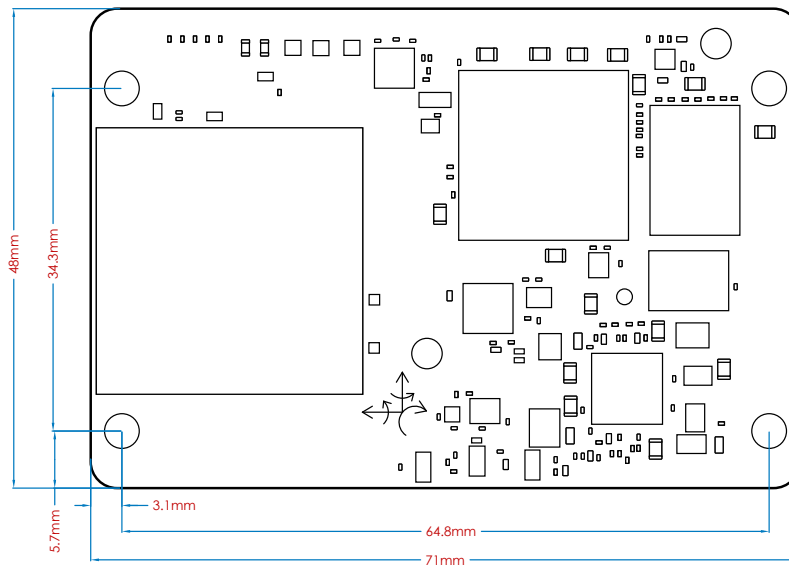

Figure 5: Top View

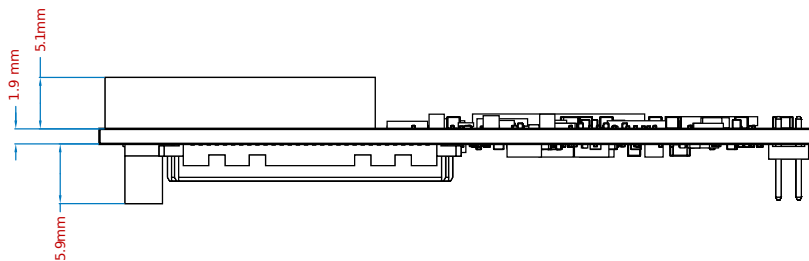

Figure 6: Side View

All dimensions are in millimeters. Drawing not to scale.

### Notes

1. Mass 26g.
2. M3 mounting holes are plated through and are not connected internally to ground.

## Errata

1. **External clock input:** Hardware revision 00108-05 is not capable of switching between the on-board oscillator and an external clock. These boards shipped from February through May of 2017 and can be determined from the small sticker on the front of the Piksi Multi Board.
2. **Hardware features awaiting software support:** Some features are implemented on Piksi Hardware but do not yet have software support including hot start, warm start, CAN communication, and GNSS navigation from constellations other than GPS. These features are expected to come on-line during the recurring firmware releases. Access to the CAN interface is expected to be provided through Piksi Multi's SDK when it becomes available.